

Valve plug MSC SuperSeal male with cable

PUR 2x0.75 bk 5m

Xtreme - Outdoor

Female straight

max. 24 V DC

2-pole

without components

without cable sleeves

Plastic housings with good resistance against chemicals and oils.

The resistance to aggressive media should be individually tested for your application. Further details on request.

Further cable lengths on request.

[Link to Product](#)

Illustration

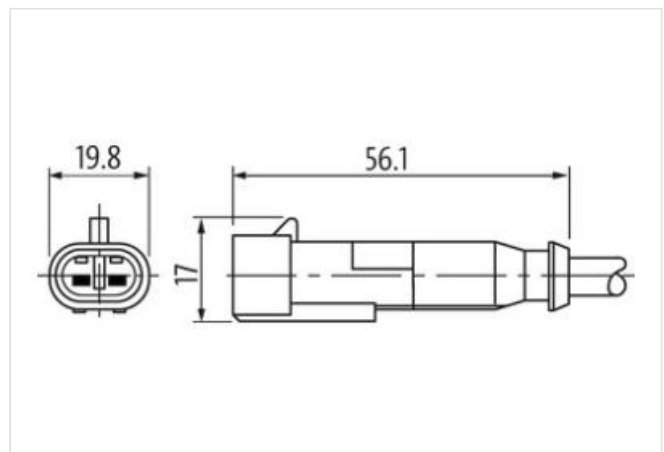
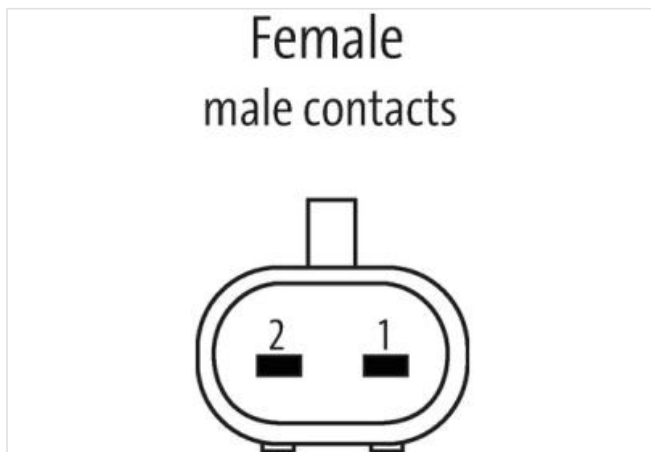
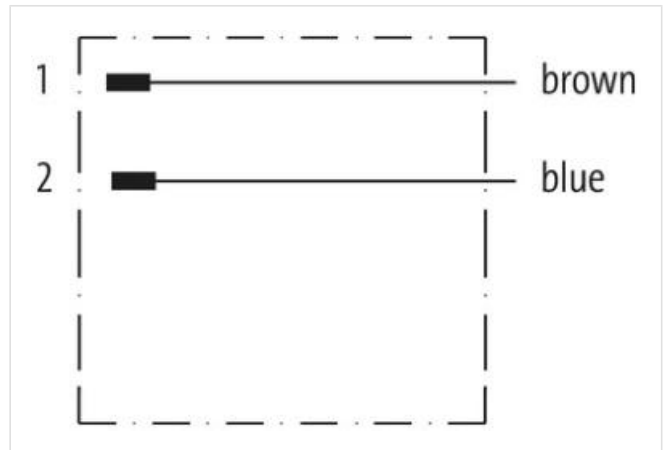

Product may differ from Image

Cable length 5 m

Side 1

Mounting method	inserted
Coating contact	tin-plated
Family construction form	SuperSeal

suitable for corrugated tube (internal Ø)	11 mm
Material contact	Copper alloy
No. of poles	2
Commercial data	
ECLASS-6.0	27279218
ECLASS-6.1	27279218
ECLASS-7.0	27279218
ECLASS-8.0	27279218
ECLASS-9.0	27060312
ECLASS-10.1	27060312
ECLASS-11.1	27060312
ECLASS-12.0	27060312
ETIM-5.0	EC000830
customs tariff number	85444290
GTIN	4048879655095
Packaging unit	1
Electrical data Supply	
Operating voltage DC max.	24 V
Current operating per contact max.	8 A
Diagnostics	
Status indication LED	no
Installation Connection	
Family construction form	AMP SuperSeal 1.5
Device protection Electrical	
Degree of protection (EN IEC 60529)	IP67
Additional condition protection degree	inserted, locked
Pollution Degree	3
Rated surge voltage	1,5 kV
Additional suppressor	without components
Mechanical data Material data	
Color housing	black
Material gasket	Silicon
Material housing	Plastic
Material overmolding	PUR
Mechanical data Mounting data	
Looking techniques	Snap-in connector
Environmental characteristics Climatic	
Operating temperature min.	-40 °C
Operating temperature max.	125 °C
Additional condition temperature range	depending on cable quality
Important installation notes	
Note on strain relief	Protect the connectors by suitable measures from mechanical loads, e.g. by the usage of cable ties.
Note on bending radius	Attention: Observe the permissible bending radii when laying cables, as the IP protection class can be endangered by excessive bending forces.